

KX

Kunststoff-Scheibenleuchte Plastic edge luminaire

Innovative Kunststoff-Scheibenleuchte für Universalmontage Wand/Decke/Deckeneinbau/Ausleger. Konisch zulaufendes Gehäuse für ansprechende Optik. Geeignet für Dauer- oder Bereitschaftsschaltung. Planungssicherheit durch werkzeuglosen, variablen Einsatz der Piktogramme vor Ort. Steckbares Piktogrammset (links, rechts, unten, neutral) standardmäßig im Lieferumfang enthalten. Rettungszeichenleuchte gem. DIN EN 60598-1, DIN EN 60598-2-22 und DIN EN 1838.

- Als kombinierte Sicherheits- und Rettungszeichenleuchte mit ERT-LED und klarer Haube erhältlich
- Einfache Piktomontage (ein- und doppelseitig), Stecktechnik

Innovative high-grade plastic edge luminaire for universal mounting wall/ceiling/recessed ceiling/pendant. Tapered design housing for appealing area perception. Applicability; maintained or non-maintained operation mode. Improved reliability through easy to install universal use of pictograms. Universal insert pictogram set (left, right, down, neutral) included. Signs according EN 60598-1, EN 60598-2-22 and EN 1838 norms.

- Also available as combined safety light/rescue sign with ERT-LED and clear cover
- Simple pictogram mounting (one and double-sided), plugging-technique





Weißes Kunststoffgehäuse

30m Erkennungsweite

komplettes Piktogrammset (ISO 7010)

IP40

LED Leuchtmittel

Universalmontage

-5° bis +40°C

White plastic housing

30m viewing distance

complete set of pictographs (ISO 7010)

IP40









LED illuminant



Universal mounting

-5° up to +40°C



Kunststoff-Scheibenleuchte Plastic edge luminaire

Ausführung Version	Bestellnummern nach Montageart Order numbers acc. to mounting Universalmontage <i>Universal mounting</i>	Überbrückungszeit Operating Time	Leuchtmittel Illuminant	Batterie Battery	
Einzelbatterieleuchten Self-contained luminaires					
LED, 230V AC, 3h	KXU 003 mit weißer Haube (with white cover)	3h	LED 2W	4,8V/2,0Ah	
LED, 230V AC, 8h	KXU 008 mit weißer Haube (with white cover)	8h	LED 2W	4,8V/2,0Ah	
LED, 230V AC, 3h	KXU 013 mit klarer Haube (with clear cover)	8h	LED 2W - 150lm	4,8V/2,0Ah	
LED, 230V AC, 8h	KXU 018 mit klarer Haube (with clear cover)	8h	LED 2W - 120lm	2x 4,8V/2,0Ah	
ERT-LED, 230V AC, 3h	KXU 023 mit klarer Haube (with clear cover)	3h	LED 4W - 520lm	2x 4,8V/2,0Ah	
Einzelbatterieleuchten mit Selbsttestfunktion Self-contained luminaires with SelfControl module					
LED, 230V AC, 3h	KXU 003SC mit weißer Haube (with white cover)	3h	LED 2W	4,8V/2,0Ah	
LED, 230V AC, 3h	KXU 008SC mit weißer Haube (with white cover)	8h	LED 2W	4,8V/2,0Ah	
LED, 230V AC, 8h	KXU 013SC mit klarer Haube (with clear cover)	3h	LED 2W - 150lm	4,8V/2,0Ah	
LED, 230V AC, 3h	KXU 018SC mit klarer Haube (with clear cover)	8h	LED 2W - 120lm	2x 4,8V/2,0Ah	
ERT-LED, 230V AC, 3h	KXU 023SC mit klarer Haube (with clear cover)	3h	LED 4W - 520lm	2x 4,8V/2,0Ah	
ERT-LED, 230V AC, 8h	KXU 028SC mit klarer Haube (with clear cover)	8h	LED 4W - 520lm	2x 4,8V/2,0Ah	
Einzelbatterieleuchten mit Wireless Professional Modul Self-contained luminaires with Wireless Professional module					
LED, 230V AC, 3h	KXU 003WL mit weißer Haube (with white cover)	3h	LED 2W	4,8V/2,0Ah	
LED, 230V AC, 3h	KXU 013WL mit klarer Haube (with clear cover)	3h	LED 3W - 150lm	12V/0,8Ah	
LED, 230V AC, 3h	KXU 018WL mit weißer Haube (with white cover)	8h	LED 3W	12V/0,8Ah	

Ausführung Version	Bestellnummern nach Montageart Order numbers acc. to mounting Universalmontage <i>Universal mounting</i>	Leuchtmittel Illuminant	
Leuchten für Zentralanlagen AC/DC Luminaires for central power systems AC/DC			
LED, 230V AC/DC	KXU 009 mit weißer Haube (with white cover)	LED 2W	
LED, 230V AC/DC	KXU 019 mit klarer Haube (with clear cover)	LED 3W	
ERT-LED, 230V AC/DC	KXU 029 mit klarer Haube (with clear cover)	LED 4W	
Leuchten für Zentralanlagen AC/DC inkl. Überwachungsbaustein Luminaires for central power systems AC/DC incl. monitoring module			
LED, 230V AC/DC	KXU 009ML mit weißer Haube (with white cover)	LED 2W	
LED, 230V AC/DC	KXU 019ML mit klarer Haube (with clear cover)	LED 3W	
ERT-LED, 230V AC/DC	KXU 029ML mit klarer Haube (with clear cover)	LED 4W	



Maße KXU
Dimensions KXU

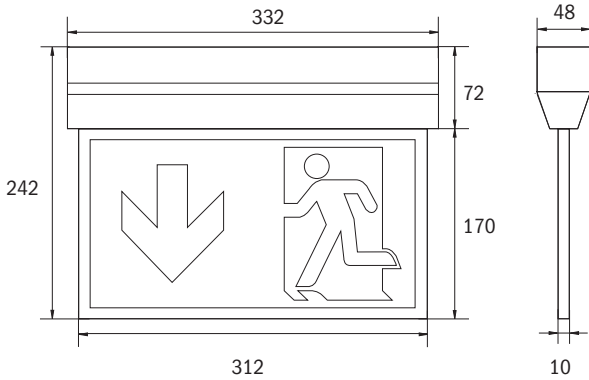

Bohrabstände KXU
Drilling distances KXU

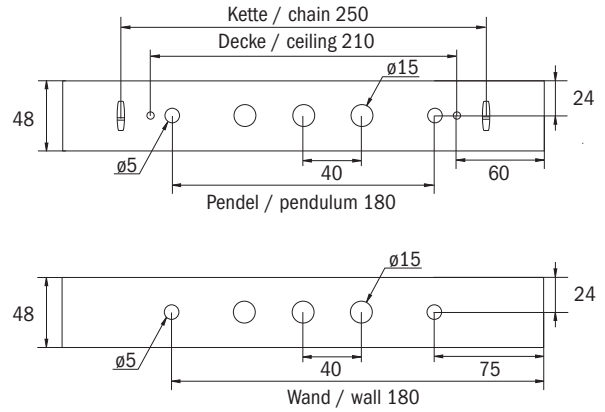

Maße KXE Einbaurahmen
Dimensions KXE Recessed frame

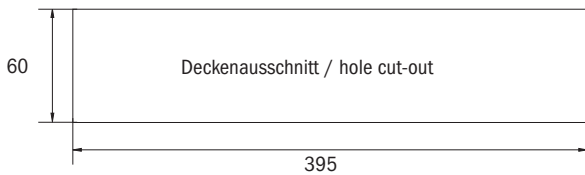

Lochausschnitt KXE Einbaurahmen
Hole Cut-out KXE Recessed frame

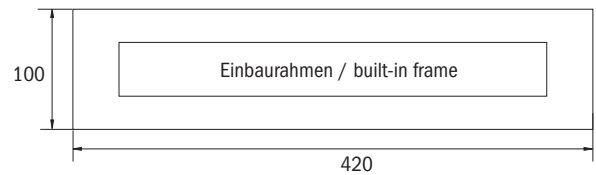

Zubehör / Accessories

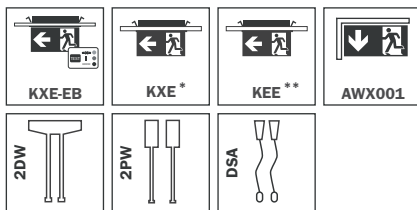

* KXE: für Rettungszeichenleuchten
for emergency sign luminaires

** KEE: für Kombinations Rettungszeichenleuchte & Sicherheitsleuchte
for combination emergency sign luminaires & rescue sign luminaire

Abstandstabelle KXU029 mit klarer Haube für ebene Fluchtwege
Distance table KXU029 with clear cover for plane emergency routes

Montagehöhe (m) Mounting level (m)					
2.00	8.02	19.70	16.50	5.35	2.00
2.50	8.72	21.94	18.24	5.64	1.95
3.00	9.23	23.93	19.32	5.75	1.87
3.50	9.62	25.62	20.24	5.70	1.63
4.00	9.90	26.71	20.65	5.51	1.30

Die Abstandstabelle basiert auf folgenden Parametern: Wartungsfaktor: 0.8; Notbeleuchtungsfaktor 1.00; Minimale Beleuchtungsstärke auf der Mittellinie: 1.00 lux; Minimale Beleuchtungsstärke auf der halben Rettungswegbreite: 0.50 lux; Gleichmäßigkeit auf der Mittellinie maximal 40:1; Breite des Rettungsweges 2.00m

The distance table is based on the following parameters: Maintenance factor: 0.8; emergency lighting factor 1.00; Minimum illumination on the center line: 1.00 lux; Minimum illumination on the half width of the rescue route: 0.50 lux; uniformity on the midline maximum 40:1; Width of the rescue route 2.00m

*) Rettungszeichenleuchten sollten für eine eindeutige Erkennbarkeit nicht höher als 20° über der horizontalen Blickrichtung montiert sein.
For a clear identification exit signs should be mounted not higher than 20° above the horizontal line of sight.

KSU

Kunststoff-Scheibenleuchte *Plastic edge luminaire*

Innovative Kunststoff LED Scheibenleuchte für Universalmontage. Leuchte zur einfachsten Montage aus nur 3 Teilen bestehend. Werkzeuglos auf integriertem Decken- bzw. Wandschnellmontagesystem montierbar. Geeignet für Dauer- oder Bereitschaftsschaltung. Planungssicherheit durch werkzeuglosen, variablen Einsatz der Piktogramme vor Ort. Piktogrammset (links, rechts, unten, neutral) standardmäßig im Lieferumfang enthalten. Rettungszeichenleuchte gem. DIN EN 60598-1, DIN EN 60598-2-22 und DIN EN 1838.

Innovative high-grade plastic edge LED luminaire for universal mounting . This luminaire has the simplest installation using in the design only 3 parts. Applicability; maintained or non-maintained operation mode. Improved reliability through easy to install universal use of pictograms. Universal pictogram set (left, right, down, neutral) included. Signs according EN 60598-1, EN 60598-2-22 and EN 1838 norms.





Weißes Kunststoffgehäuse

22m Erkennungsweite

komplettes Piktogrammset (ISO 7010)

IP54

LED Leuchtmittel

Universalmontage

-5° bis +40°C

White plastic housing

22m viewing distance

complete set of pictographs (ISO 7010)

IP54

LED illuminant

Universal mounting

-5° up to +40°C

KSC

Kunststoff-Scheibenleuchte *Plastic edge luminaire*

Innovative Kunststoff LED Rettungszeichen- und Sicherheitsleuchte für Universalmontage. Leuchte zur einfachsten Montage aus nur 3 Teilen bestehend. Werkzeuglos auf integrierendem Decken- bzw. Wand-schnellmontagesystem montierbar. Geeignet für Dauer- oder Bereitschaftsschaltung. Planungssicherheit durch werkzeuglosen, variablen Einsatz der Piktogramme vor Ort. Piktogrammset (links, rechts, unten, neutral) standardmäßig im Lieferumfang enthalten. Rettungszeichenleuchte gem. DIN EN 60598-1, DIN EN 60598-2-22 und DIN EN 1838.

Die Leuchte KSC ist zudem zur Beleuchtung von Brandbekämpfung- als auch Erste Hilfe- Stellen, mit den nach EN 1838 min. geforderten 5 Lux an der Einrichtung, konzipiert.

Innovative high-grade LED exit sign and emergency luminaire for universal mounting. This luminaire has the simplest installation using in the design only 3 parts. Applicability; maintained or non-maintained operation mode. Improved reliability through easy to install universal use of pictograms. Universal pictogram set (left, right, down, neutral) included. Signs according to EN 60598-1, EN 60598-2-22 and EN 1838 norms.

The KSC luminaire is also designed for illumination of fire fighting and first aid facilities with at least 5 lux on the equipment according to EN 1838.





Weißes Kunststoffgehäuse

22m Erkennungsweite

komplettes Piktogrammset (ISO 7010)

IP54

LED Leuchtmittel

Universalmontage

-5° bis +40°C

White plastic housing

22m viewing distance

complete set of pictographs (ISO 7010)

IP54

LED illuminant

Universal mounting

-5° up to +40°C

KS

Kunststoff-Scheibenleuchte Plastic edge luminaire



Ausführung Version	Bestellnummern nach Montageart Order numbers acc. to mounting Universalmontage Universal mounting	Überbrückungszeit Operating Time	Leuchtmittel Illuminant	Batterie Battery	
Einzelbatterieleuchten Self-contained luminaires					
LED, 230V AC, 3h	KSU 003 mit weißer Haube (with white cover)	3h	LED	4,8V/0,5Ah NiMH	
LED, 230V AC, 3h	KSU 013 mit weißer Haube (with white cover)	3h	LED 2W	3,2V/0,57Ah LiFePO4	
Einzelbatterieleuchten mit Selbsttestfunktion Self-contained luminaires with SelfControl module					
LED, 230V AC, 3h	KSU 003SC mit weißer Haube (with white cover)	3h	LED	4,8V/0,5Ah NiMH	
LED, 230V AC, 3h	KSC 013SC mit klarer Haube (with clear cover)	3h	LED 2W - 170lm	3,2V/3,0Ah LiFePO4	
LED, 230V AC, 3h	KSU 013SC mit weißer Haube (with white cover)	3h	LED 2W	3,2V/0,57Ah LiFePO4	
LED, 230V AC, 3h	KSC 013SC mit klarer Haube (with clear cover)	3h	LED 2W - 170lm	3,2V/3,0Ah LiFePO4	
LED, 230V AC, 8h	KSC 018SC mit klarer Haube (with clear cover)	8h	LED 2W - 76lm	3,2V/3,0Ah LiFePO4	
Einzelbatterieleuchten mit Wireless Professional Modul Self-contained luminaires with Wireless Professional module					
LED, 230V AC, 1h	KSU 001WL mit white Haube (with white cover)	1h	LED	4,8V/0,5Ah NiMH	
LED, 230V AC, 3h	KSC 013WL mit klarer Haube (with clear cover)	3h	LED 2W - 170lm	3,2V/3,0Ah LiFePO4	
LED, 230V AC, 8h	KSC 018WL mit klarer Haube (with clear cover)	8h	LED 2W - 76lm	3,2V/3,0Ah LiFePO4	
LED, 230V AC, 8h	KSU 018WL mit weißer Haube (with white cover)	8h	LED 2W	3,2V/3,0Ah LiFePO4	

Ausführung Version	Bestellnummern nach Montageart Order numbers acc. to mounting Universalmontage Universal mounting	Leuchtmittel Illuminant	
Leuchten für Zentralanlagen AC/DC Luminaires for central power systems AC/DC			
LED, 230V AC/DC	KSU 019 mit weißer Haube (with white cover)	LED 2W	
Leuchten für Zentralanlagen AC/DC inkl. Überwachungsbaustein Luminaires for central power systems AC/DC incl. monitoring module			
LED, 230V AC/DC	KSU 019ML mit weißer Haube (with white cover)	LED 2W	
LED, 230V AC/DC	KSC 019ML mit klarer Haube (with clear cover)	LED 2W - 200lm	

Abstandstabelle KSC013 für ebene Fluchtwege
Distance table KSC013 for plane emergency routes

Montagehöhe (m) Mounting level (m)					
2.00	2.86	7.25	7.12	6.94	2.65
2.50	1.27	7.68	7.64	7.32	2.98
3.00	1.15	6.47	6.16	7.91	2.90
3.50	1.14	3.71	6.05	8.37	2.64
4.00	1.15	3.34	5.69	8.38	2.50

Die Abstandstabelle basiert auf folgenden Parametern: Wartungsfaktor: 0.8; Notbeleuchtungsfaktor 1.00; Minimale Beleuchtungsstärke auf der Mittellinie: 1.00 lux; Minimale Beleuchtungsstärke auf der halben Rettungswegbreite: 0.50 lux; Gleichmäßigkeit auf der Mittellinie maximal 40:1; Breite des Rettungsweges 2.00m

The distance table is based on the following parameters: Maintenance factor: 0.8; emergency lighting factor 1.00; Minimum illumination on the center line: uniformity on the midline maximum 40:1; Width of the rescue route 2.00m



Maße KSU
Dimensions KSU

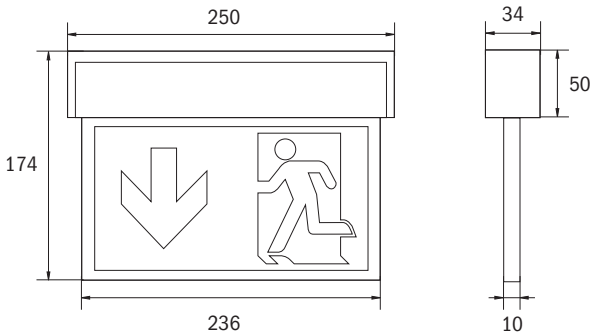

Zubehör / Accessories

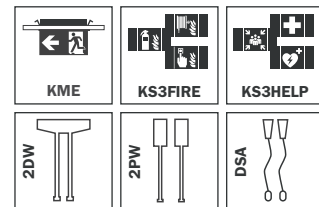

Bohrabstände KSU Decke/Wand
Drilling distances KSU ceiling/wall

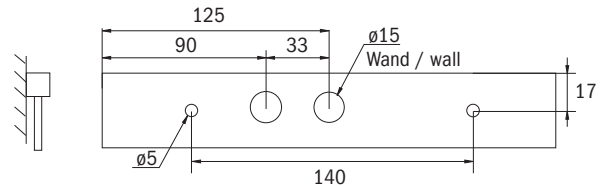
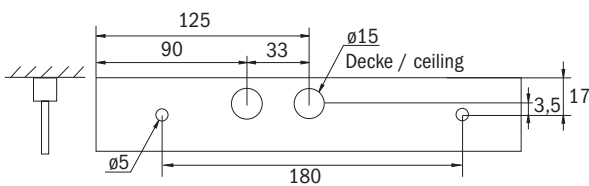

KME Einbaurahmen
KME Recessed frame

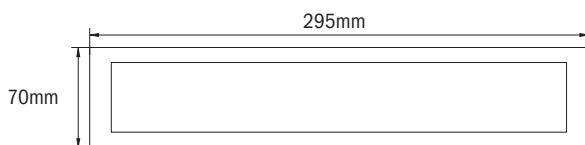

Lochausschnitt KME Einbaurahmen
Hole cut-out KME recessed frame

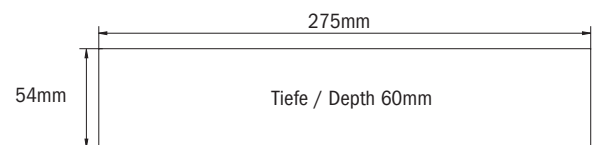

Lichtverteilung KSC013 – gemessen 1m über dem Boden, Montagehöhe der Leuchte 2,20m
Light beam KSC013 – 1m above the ground, mounting height of the luminaire 2,20m

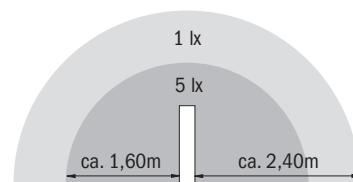
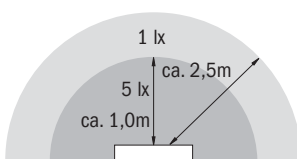

Die Abstandstabelle basiert auf folgenden Parametern: Wartungsfaktor: 0.8; Notbeleuchtungsfaktor 1.00; Minimale Beleuchtungsstärke auf der Mittellinie: 1.00 lux; Minimale Beleuchtungsstärke auf der halben Rettungswegbreite: 0.50 lux; Gleichmäßigkeit auf der Mittellinie maximal 40:1; Breite des Rettungsweges 2.00m

The distance table is based on the following parameters: Maintenance factor: 0.8; emergency lighting factor 1.00; Minimum illumination on the center line: 1.00 lux; Minimum illumination on the midline maximum 40:1; Width of the rescue route 2.00m

*) Rettungszeichenleuchten sollten für eine eindeutige Erkennbarkeit nicht höher als 20° über der horizontalen Blickrichtung montiert sein.
For a clear identification exit signs should be mounted not higher than 20° above the horizontal line of sight.

KT / KM

Universal-Kunststoffleuchte Universal Plastic luminaire

Rettungszeichenleuchte gem. DIN EN 60598-1, DIN EN 60598-2-22 und DIN EN 1838.

Schlanke, elegante, konvexe, zum Betrachter geneigte Kunststoffleuchte, die sich nach unten stufenlos symmetrisch verjüngt. Für Universalmontage (Wand/Decke/Deckeneinbau/Ausleger). Leuchte zur einfachsten Montage aus nur 3 Teilen bestehend. Werkzeuglos auf integriertem Decken- bzw. Wandschnellmontagesystem montierbar. Netzspannungsfrei bei Demontage der Leuchte. Geeignet für Dauer- oder Bereitschaftsschaltung. Planungssicherheit durch werkzeuglosen, variablen Einsatz der Piktogramme vor Ort. Piktogrammset (links, rechts, unten, neutral) standardmäßig im Lieferumfang enthalten.

Emergency sign luminaire in accordance to DIN EN 60598-1, DIN EN 60598-2-22 and DIN EN 1838.

Slim, elegant, convex, synthetic luminaire tilted towards the viewer, continuously symmetrically tapered towards the bottom. For universal mounting (wall/ceiling surface mount/integrated ceiling mount/brackets). For mounting convenience, the luminaire consists of only 3 parts. Toolfree mountable on the quick assembly integrated ceiling mounting or wall mounting system. The luminaire has zero potential when dismantled. Suitable for continuous mode or stand-by mode. Reliable planning due to a toolfree and variable, on-site use of the pictograms. Set of pictograms (left, right, bottom, neutral) is included in the scope of delivery.





Kunststoff, weiß
komplettes Piktogrammset (ISO 7010)
IP54
Universalmontage
-5° bis +40°C

*Plastic, white
complete set of pictographs (ISO 7010)
IP54
universal mounting
-5° up to +40°C*

KT / KM

Universal-Kunststoffleuchte Universal Plastic luminaire

KM
24m



Ausführung Version	Bestellnummern nach Montageart Order numbers acc. to mounting Universalmontage universal mounting	Überbrückungszeit Operating Time	Leuchtmittel Illuminant	Batterie Battery	
Einzelbatterieleuchten Self-contained luminaires					
LED, 230V AC, 3h	KMU 003	3h	LED	4,8V/0,5Ah NiMH	
Einzelbatterieleuchten mit Selbsttestfunktion Self-contained luminaires with SelfControl module					
LED, 230V AC, 3h	KMU 003SC	3h	LED	4,8V/0,5Ah NiMH	
LED, 230V AC, 3h	KMU 013SC	3h	LED 2W	3,2V/0,57Ah LiFePO4	
LED, 230V AC, 8h	KMU 018SC	8h	LED 2W	3,2V/3,0Ah LiFePO4	
Einzelbatterieleuchten mit Wireless Professional-Modul Self-contained luminaires with Wireless Professional-module					
LED, 230V AC, 1h	KMU 001WL	1h	LED	4,8V/0,5Ah NiMH	
LED, 230V AC, 3h	KMU 013WL	3h	LED 2W	3,2V/3,0Ah LiFePO4	
LED, 230V AC, 8h	KMU 018WL	8h	LED 2W	3,2V/3,0Ah LiFePO4	

Ausführung Version	Bestellnummern nach Montageart Order numbers acc. to mounting Universalmontage universal mounting	Leuchtmittel Illuminant
Leuchten für Zentralanlagen AC/DC Luminaires for central power systems AC/DC		
LED, 230V AC/DC	KMU 019	LED 2W
Leuchten für Zentralanlagen AC/DC inkl. Überwachungsbaustein Luminaires for central power systems AC/DC incl. monitoring module		
LED, 230V AC/DC	KMU 019ML	LED 2W

KT
16m

Ausführung Version	Bestellnummern nach Montageart Order numbers acc. to mounting Universalmontage universal mounting	Überbrückungszeit Operating Time	Leuchtmittel Illuminant	Batterie Battery
Einzelbatterieleuchten Self-contained luminaires				
LED 230V AC, 3h	KTU 003	3h	LED	4,8V/0,3Ah NiMH
LED, 230V AC, 3h	KTS 003	3h	LED	4,8V/0,3Ah NiMH

KME Einbaurahmen
KME recessed frame

KTS Scheibenleuchte
KTS edge luminaire

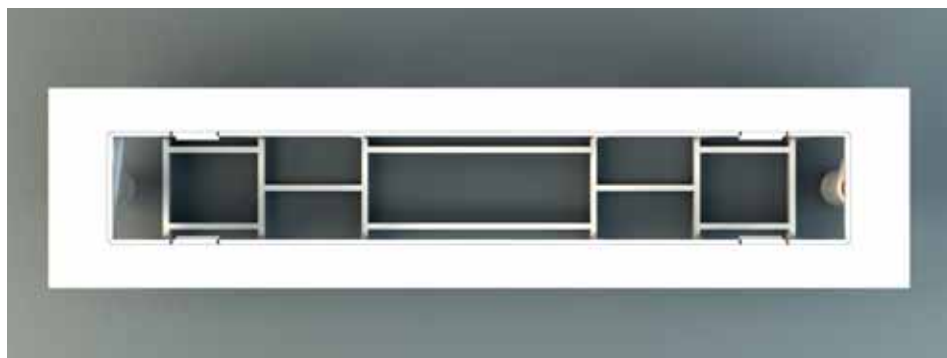

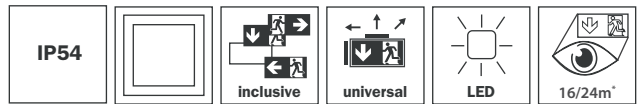

Maße KM
Dimensions KM

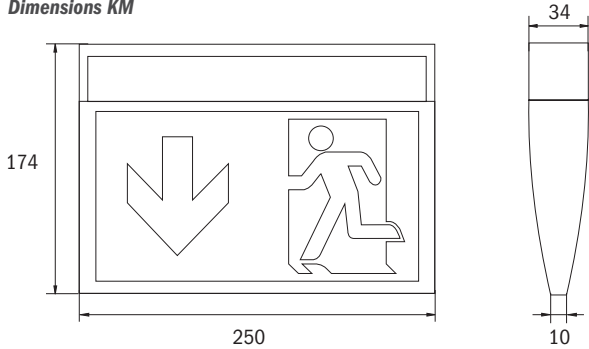

KME Einbaurahmen / Lochausschnitt
KME Recessed frame / hole cut out

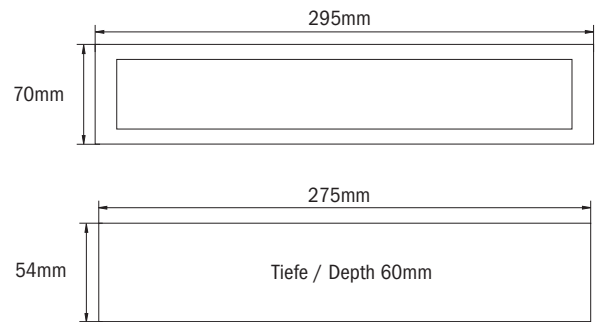

Bohrabstände KM Decke/Wand
Drilling distances KM ceiling/wall

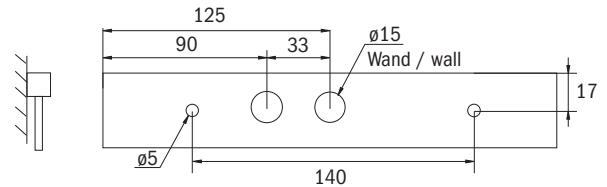
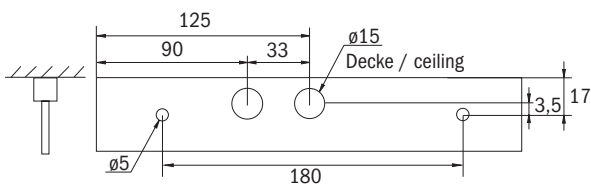

Zubehör / Accessories

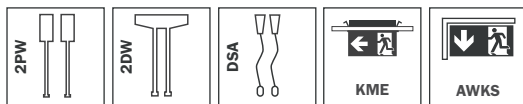

Maße KT / Dimensions KT

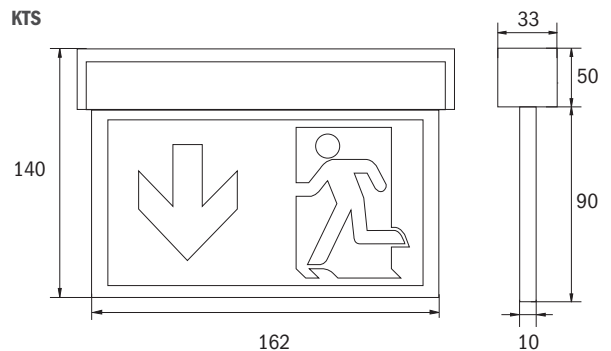
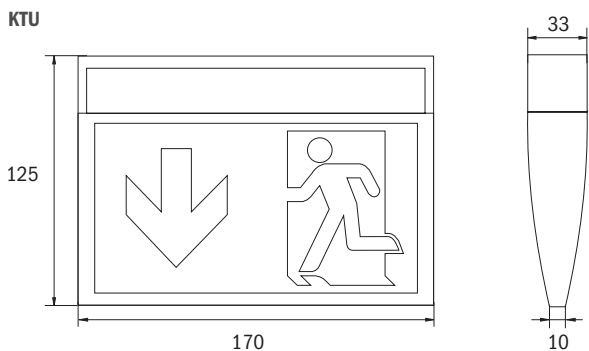

Bohrabstände KT Decke/Wand
Drilling distances KT ceiling/wall

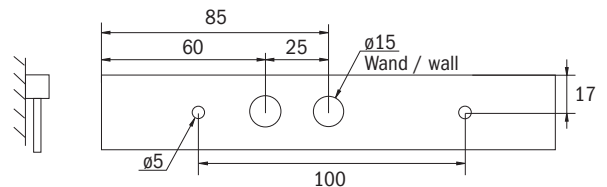
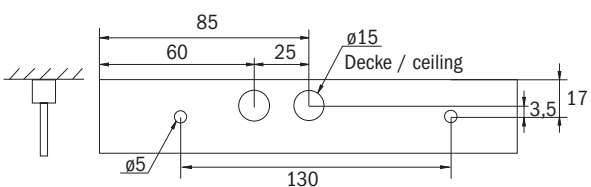

*) Rettungszeichenleuchten sollten für eine eindeutige Erkennbarkeit nicht höher als 20° über der horizontalen Blickrichtung montiert sein.
For a clear identification exit signs should be mounted not higher than 20° above the horizontal line of sight.

GM / GX

Kunststoff-Scheibenleuchte *Plastic edge luminaire*

LED-Rettungszeichenleuchte nach DIN EN 60598-1, DIN EN 60598-2-22, DIN EN 7010 und DIN EN 1838.

Die vielfältige LED-Rahmenleuchte ist als Wand-, Decken- oder Seilmontage erhältlich. Sie glänzt neben geradlinigem Design mit einer homogenen Ausleuchtung des Piktogrammes. Planungssicherheit erhalten Sie durch werkzeuglosen, variablen Einsatz der Piktogramme vor Ort.

LED escape route luminaire in accordance with DIN EN 60598-1, EN 60598-2-22, EN 7010 and DIN EN 1838th

The versatile LED frame luminaire is available for wall, ceiling or cors suspended mounting. It shines alongside straightforward design with a homogeneous illumination of the pictogram. Planning security you get by variable use and change of pictograms without tools on site.



GMU



GXS



GXD



GMU



GXW

Weißes Kunststoffgehäuse

24m (GM) oder 30m (GX) Erkennungsweite

komplettes Piktogrammset (ISO 7010)

IP40

LED Leuchtmittel

Als Deckenleuchte, mit Seilpendel (flexibel bis 1m) oder als Einbauleuchte erhältlich (GX)

Wand oder Deckenmontage (GM)

Als Einzelbatterieleuchte immer mit SelfControl in Dauerschaltung

-5° bis +40°C

White plastic housing

24m (GM) or 30m (GX) viewing distance

complete set of pictographs (ISO 7010)

IP40

LED illuminant

Available as ceiling mount, with cord suspension (flexible up to 1m) or as recessed mounted luminaire (GX)



Wall- or ceiling mounting (GM)



SelfControl by default for self-contained luminaires in non-maintained mode

-5° up to +40°

GM / GX

Kunststoff-Scheibenleuchte Plastic edge luminaire

GM 24m	Ausführung Version	Bestellnummern nach Montageart Order numbers acc. to mounting			Überbrückungszeit Operating Time	Leuchtmittel Illuminant	Batterie Battery
	Universal						
Einzelbatterieleuchten mit Selbsttestfunktion Self-contained luminaires with SelfControl module							
	LED, 230V AC, 3h	GMU 003SC			3h	LED 3,5W	3,6V/0,9Ah 
	Ausführung Version	Bestellnummern nach Montageart Order numbers acc. to mounting				Leuchtmittel Illuminant	
	Universal						
Leuchten für Zentralanlagen AC/DC Luminaires for central power systems AC/DC							
	LED, 230V AC/DC	GMU 009				LED 3,5W	
Leuchten für Zentralanlagen AC/DC inkl. Überwachungsbaustein Luminaires for central power systems AC/DC incl. monitoring module							
	LED, 230V AC/DC	GMU 009ML				LED 3,5W	

GX 30m	Ausführung Version	Bestellnummern nach Montageart Order numbers acc. to mounting			Überbrückungszeit Operating Time	Leuchtmittel Illuminant	Batterie Battery
		Decke ceiling	Seilpendel cord suspension	Wandeinbau recessed wall			
Einzelbatterieleuchten mit Selbsttestfunktion Self-contained luminaires with SelfControl module							
	LED, 230V AC, 3h	GXD 003SC	GXS 003SC	GXW 003SC	3h	LED	3,6V/0,9Ah 
	Ausführung Version	Bestellnummern nach Montageart Order numbers acc. to mounting				Leuchtmittel Illuminant	
		Decke ceiling	Seilpendel cord suspension	Wandeinbau recessed wall			
Leuchten für Zentralanlagen AC/DC Luminaires for central power systems AC/DC							
	LED, 230V AC/DC	GXD 009	GXS 009	GXW 009		LED 4W	
Leuchten für Zentralanlagen AC/DC inkl. Überwachungsbaustein Luminaires for central power systems AC/DC incl. monitoring module							
	LED, 230V AC/DC	GXD 009ML	GXS 009ML	GXW 009ML		LED 4W	

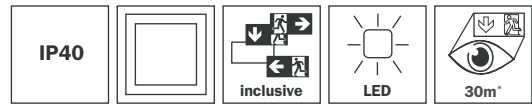

Maße GMU
Dimensions GMU

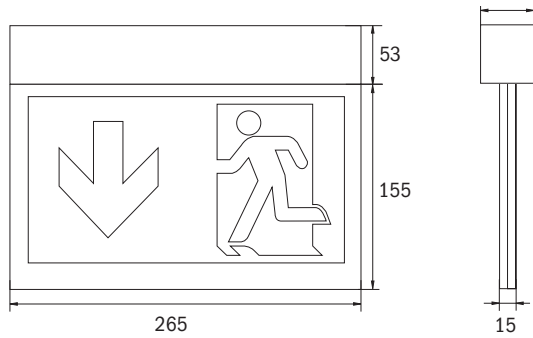

Bohrabstände GMU
Drilling distances GMU

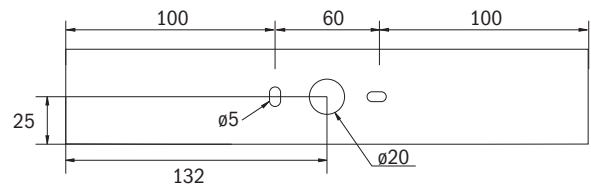

Maße GXD/GXS
Dimensions GXD/GXS

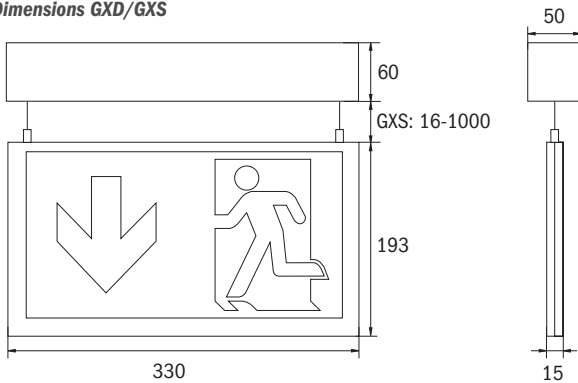

Maße GXW
Dimensions GXW

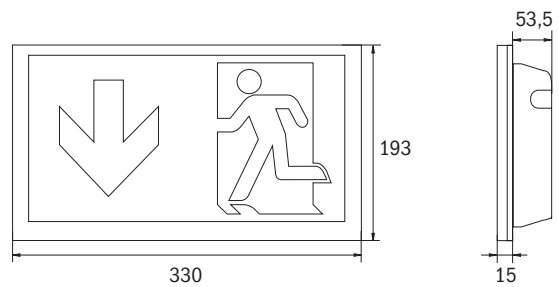

Bohrabstände GXD/GXS
Drilling distances GXD/GXS

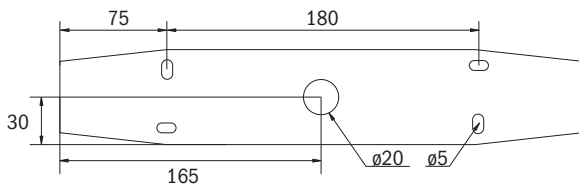

Zubehör / Accessories



Abmessungen GXE Einbaurahmen
Dimensions GXE Recessed mounting frame

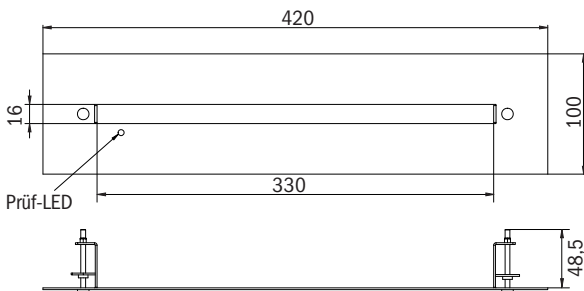

GXW Lochausschnitt / Hole cut-out

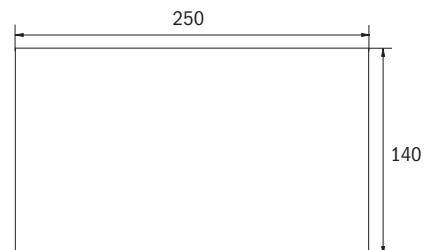

*) Rettungszeichenleuchten sollten für eine eindeutige Erkennbarkeit nicht höher als 20° über der horizontalen Blickrichtung montiert sein.
For a clear identification exit signs should be mounted not higher than 20° above the horizontal line of sight.

KC

Kunststoffleuchte Plastic luminaire

Schlanke konvexe Rettungszeichen- und Sicherheitsleuchte aus Kunststoff für Wandmontage. Rettungszeichenleuchte mit steckbaren, Lösungsmittelfreien, innenliegenden Piktogrammset standardmäßig im Lieferumfang enthalten. Gleichzeitig ohne Einsatz der Piktogramme als Sicherheitsleuchte mit enthaltener glasklarer Abdeckung zu verwenden. Rettungszeichen- / Sicherheitsleuchte gem. DIN EN 60598-1, DIN EN 60598-2-22 und DIN EN 1838.

Slightly curved high-grade exit sign and emergency luminaire in plastic for wall mounting. Signage with pluggable, solvent-free, internally mounted pictogram. Pictogram set included. This luminaire can be used without pictogram as an emergency lighting luminaire with a clear cover. Escape route/Exit sign/ emergency luminaire according EN 60598-1, EN 60598-2-22 and EN 1838 norms.







Weißes Kunststoffgehäuse
30m Erkennungsweite
komplettes Piktogrammset (ISO 7010)
IP54, optional IP65 (bei Deckenmontage IP40)
Erhältlich für Wand- oder Deckenmontage
-5° bis +40°C

*White plastic housing
30m viewing distance
complete set of pictographs (ISO 7010)
IP54, optional IP65 (ceiling mounted always IP40)
Available for wall or ceiling mounting
-5° up to +40°C*





KC

Kunststoffleuchte Plastic luminaire

Ausführung Version	Bestellnummern nach Montageart Order numbers acc. to mounting		Überbrückungszeit Operating Time	Leuchtmittel Illuminant	Batterie Battery	
	Wand wall	Decke ceiling				
Einzelbatterieleuchten Self-contained luminaires						
LED, 230V AC, 3h	KCW 013	KCD 013	3h	LED 3W	4,8V/2,0Ah	
LED, 230V AC, 8h	KCW 018	KCD 018	8h	LED 3W	2x 4,8V/2,0Ah	
Einzelbatterieleuchten mit Selbsttestfunktion Self-contained luminaires with SelfControl module						
LED, 230V AC, 3h	KCW 013SC	KCD 013SC	3h	LED 3W	4,8V/2,0Ah	
LED, 230V AC, 8h	KCW 018SC	KCD 018SC	8h	LED 3W	2x 4,8V/2,0Ah	
ERT-LED, 230V AC, 3h	KCW 023SC		3h	LED 3W	4,8V/2,0Ah	
ERT-LED, 230V AC, 8h	KCW 028SC		8h	LED 3W	2x 4,8V/2,0Ah	
Einzelbatterieleuchten mit Wireless Professional Modul Self-contained luminaires with Wireless Professional module						
LED, 230V AC, 3h	KCW 013WL	KCD 013WL	3h	LED 3W	12V/0,8Ah	
LED, 230V AC, 8h	KCW 018WL	KCD 018WL	8h	LED 3W	12V/0,8Ah	

Ausführung Version	Bestellnummern nach Montageart Order numbers acc. to mounting		Leuchtmittel Illuminant	
	Wand wall	Decke ceiling		
Leuchten für Zentralanlagen AC/DC Luminaires for central power systems AC/DC				
LED 230V AC/DC	KCW 019	KCD 019	LED 3W	
Leuchten für Zentralanlagen AC/DC inkl. Überwachungsbaustein Luminaires for central power systems AC/DC incl. monitoring module				
LED 230V AC/DC	KCW 019ML	KCD 019ML	LED 3W	
LED 230V AC/DC	KCW 029ML		LED 3W	

Abstandstabelle KCW029 für ebene Fluchtwege
Distance table KCW029 for plane emergency routes

Montagehöhe (m) Mounting level (m)					
2.00	3.93	10.05	9.25	8.51	3.46
2.50	4.33	10.87	10.16	9.50	3.85
3.00	4.62	11.58	10.95	10.32	4.13
3.50	4.82	12.23	11.62	11.00	4.32
4.00	4.94	12.82	12.21	11.56	4.44

Die Abstandstabelle basiert auf folgenden Parametern: Wartungsfaktor: 0.8; Notbeleuchtungsfaktor 1.00; Minimale Beleuchtungsstärke auf der Mittellinie: 1.00 lux; Minimale Beleuchtungsstärke auf der halben Rettungswegbreite: 0.50 lux; Gleichmäßigkeit auf der Mittellinie maximal 40:1; Breite des Rettungsweges 2.00m

The distance table is based on the following parameters: Maintenance factor: 0.8; emergency lighting factor 1.00; Minimum illumination on the center line: uniformity on the midline maximum 40:1; Width of the rescue route 2.00m

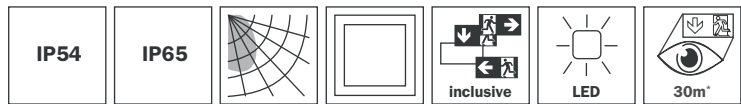

Maße KC Decke
Dimensions KC ceiling

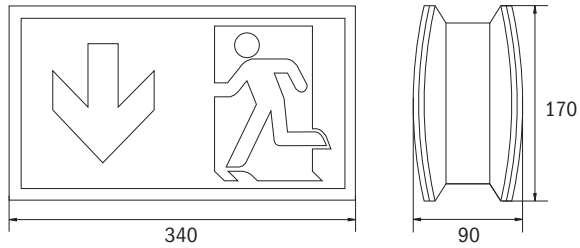

Maße KC Wand
Dimensions KC wall

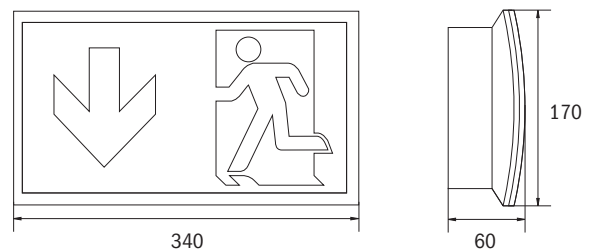

Bohrabstände KC
Drilling distances KC

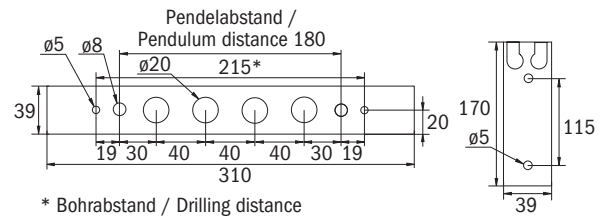
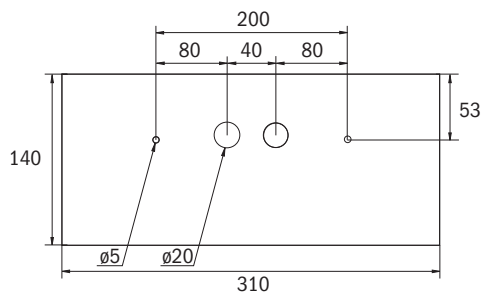

Zubehör / Accessories

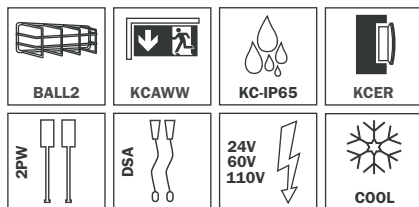

*) Rettungszeichenleuchten sollten für eine eindeutige Erkennbarkeit nicht höher als 20° über der horizontalen Blickrichtung montiert sein.
For a clear identification exit signs should be mounted not higher than 20° above the horizontal line of sight.

KD / KL

Kunststoffleuchte Plastic luminaire

Schlanke Kunststoffleuchte für Universalmontage Wand/Decke sowie Wandausleger über beiliegenden Adapter. Mit zusätzlichem Lichtaustritt nach unten. Werkzeuglos zu öffnendes Gehäuse. Geeignet für Dauer- oder Bereitschaftsschaltung. Planungssicherheit durch werkzeuglosen, variablen Einsatz der Piktogramme vor Ort. Rettungszeichenleuchte gem. DIN EN 60598-1, DIN EN 60598-2-22 und DIN EN 1838.

Slim design high-grade plastic luminaire for universal mounting (wall/ceiling or eventual at wall bracket through supplied adapter). This luminaire provides additional downward lighting to enhance safety at the egress route. Applicability; maintained or non-maintained operation mode. Improved reliability through easy to install universal use of pictograms. Signs according EN 60598-1, EN 60598-2-22 and EN 1838 norms.





KD



KL







Kunststoff, weiß
Komplettes Piktogrammset (ISO 7010)
IP54
Universalmontage inkl. Wandausleger
-5° bis +40°C

Plastic, white
complete set of pictographs (ISO 7010)
IP54
Universal mounting incl. wall bracket
-5° up to +40°C





KD / KL

Kunststoffleuchte Plastic luminaire

KD
22m

Ausführung Version	Bestellnummern nach Montageart Order numbers acc. to mounting Universalmontage universal mounting	Überbrückungszeit Operating Time	Leuchtmittel Illuminant	Batterie Battery	
Einzelbatterieleuchten self-contained luminaires					
LED, 230V AC, 3h	KDU 013	3h	LED 3W	4,8V/2,0Ah	
LED, 230V AC, 8h	KDU 018	8h	LED 3W	2x 4,8V/2,0Ah	
Einzelbatterieleuchten mit Selbsttestfunktion Self-contained luminaires with SelfControl module					
LED, 230V AC, 3h	KDU 013SC	3h	LED 3W	4,8V/2,0Ah	
LED, 230V AC, 8h	KDU 018SC	8h	LED 3W	2x 4,8V/2,0Ah	
Einzelbatterieleuchten mit Wireless Professional-Modul Self-contained luminaires with Wireless Professional-module					
LED, 230V AC, 3h	KDU 013WL	3h	LED 3W	12V/0,8Ah	
LED, 230V AC, 8h	KDU 018WL	8h	LED 3W	12V/0,8Ah	
Ausführung Version	Bestellnummern nach Montageart Order numbers acc. to mounting Universalmontage universal mounting		Leuchtmittel Illuminant		
Leuchten für Zentralanlagen AC/DC Luminaires for central power systems AC/DC					
LED, 230V AC/DC	KDU 019		LED 3W		
Leuchten für Zentralanlagen AC/DC inkl. Überwachungsbaustein Luminaires for central power systems AC/DC incl. monitoring module					
LED, 230V AC/DC	KDU 019ML		LED 3W		

KL
34m

Ausführung Version	Bestellnummern nach Montageart Order numbers acc. to mounting Universalmontage universal mounting	Überbrückungszeit Operating Time	Leuchtmittel Illuminant	Batterie Battery	
Einzelbatterieleuchten Self-contained luminaires					
LED, 230V AC, 3h	KLU 013	3h	LED 3W	4,8V/2,0Ah	
LED, 230V AC, 8h	KLU 018	8h	LED 3W	2x 4,8V/2,0Ah	
Einzelbatterieleuchten mit Selbsttestfunktion Self-contained luminaires with SelfControl module					
LED, 230V AC, 3h	KLU 013SC	3h	LED 3W	4,8V/2,0Ah	
LED, 230V AC, 8h	KLU 018SC	8h	LED 3W	2x 4,8V/2,0Ah	
Einzelbatterieleuchten mit Wireless Professional-Modul Self-contained luminaires with Wireless Professional-module					
LED, 230V AC, 3h	KLU 013WL	3h	LED 3W	12V/0,8Ah	
LED, 230V AC, 8h	KLU 018WL	8h	LED 3W	12V/0,8Ah	
Ausführung Version	Bestellnummern nach Montageart Order numbers acc. to mounting Universalmontage universal mounting		Leuchtmittel Illuminant		
Leuchten für Zentralanlagen AC/DC Luminaires for central power systems AC/DC					
LED, 230V AC/DC	KLU 019		LED 3W		
Leuchten für Zentralanlagen AC/DC inkl. Überwachungsbaustein Luminaires for central power systems AC/DC incl. monitoring module					
LED, 230V AC/DC	KLU 019ML		LED 3W		

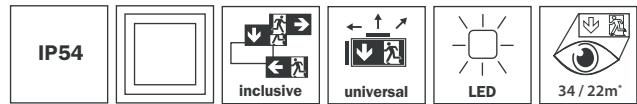

Maße KD Wand
Dimensions KD wall

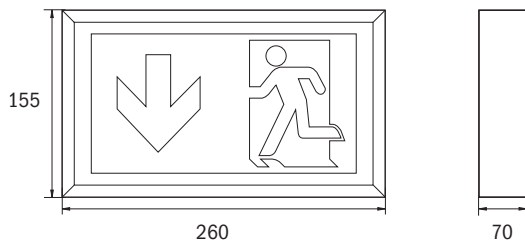

Bohrabstände KD Wand
Drilling distances KD wall

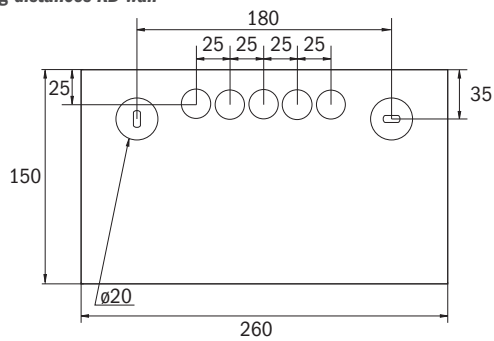

Maße KD Decke
Dimensions KD ceiling

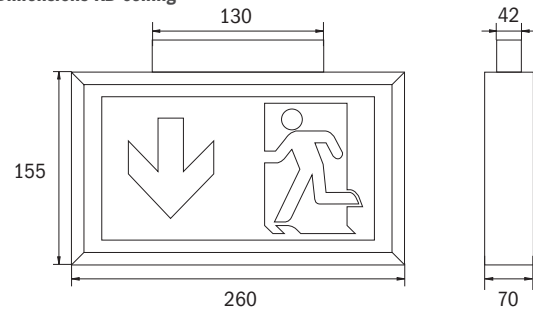

Bohrabstände KD Decke
Drilling distances KD ceiling

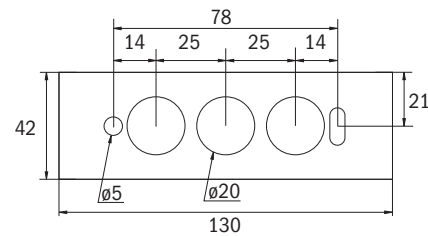

Zubehör / Accessories

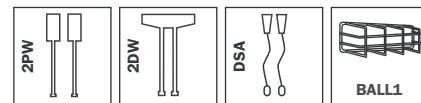

Maße KL Wand
Dimensions KL wall

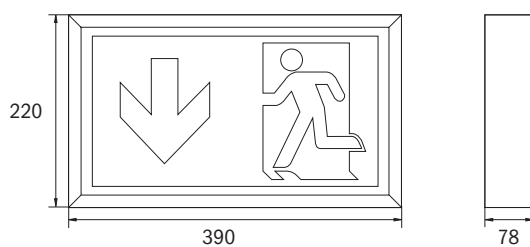

Bohrabstände KL Wand
Drilling distances KL wall

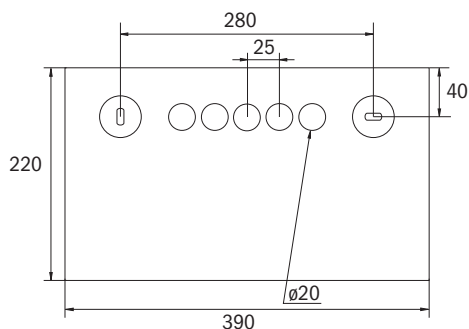

Maße KL Decke
Dimensions KL ceiling

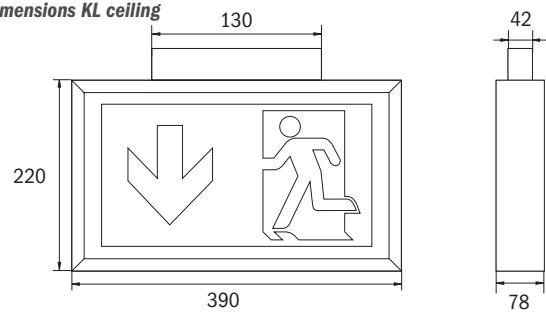

Bohrabstände KL Decke
Drilling distances KL ceiling

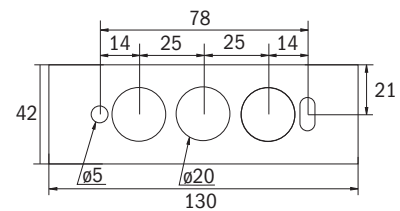

Zubehör / Accessories



*) Rettungszeichenleuchten sollten für eine eindeutige Erkennbarkeit nicht höher als 20° über der horizontalen Blickrichtung montiert sein.
For a clear identification exit signs should be mounted not higher than 20° above the horizontal line of sight.

KW

Kunststoffleuchte *Plastic luminaire*

Klassische Kunststoffleuchte für Wandmontage oder Deckenmontage. Geeignet für Dauer- oder Bereitschaftsschaltung. Piktogrammset standardmäßig im Lieferumfang enthalten. Planungssicherheit durch werkzeuglosen, variablen Einsatz der Piktogramme vor Ort. Rettungszeichenleuchte gem. DIN EN 60598-1, DIN EN 60598-2-22 und DIN EN 1838.

Classic high-grade plastic luminaire for wall or ceiling mounting. Pictogram set included. Improved reliability through easy to install universal use of pictograms. Signs according EN 60598-1, EN 60598-2-22 and EN 1838 norms.





Kunststoff, weiß

Komplettes Piktogrammset (ISO 7010)

IP54

Wand (W), Decke (D)

-5° bis +40°C







Plastic, white

Complete set of pictographs (ISO 7010)

IP54

wall (W), ceiling (D)

-5° up to +40°C

Ausführung Version	Bestellnummern nach Montageart Order numbers acc. to mounting		Überbrückungszeit Operating Time	Leuchtmittel Illuminant	Batterie Battery	
	Wand wall	Decke ceiling				
Einzelbatterieleuchten Self-contained luminaires						
LED, 230V AC, 3h	KWW 003	KWD 003	3h	LED 2W	4,8V/2,0Ah	
LED, 230V AC, 3h	KWW 013	KWD 013	3h	LED 3W	4,8V/2,0Ah	
LED, 230V AC, 8h	KWW 018	KWD 018	8h	LED 3W	2x 4,8V/2,0Ah	
Einzelbatterieleuchten mit Selbsttestfunktion Self-contained luminaires with SelfControl module						
LED, 230V AC, 3h	KWW 003SC	KWD 003SC	3h	LED 2W	4,8V/2,0Ah	
LED, 230V AC, 3h	KWW 013SC	KWD 013SC	3h	LED 3W	4,8V/2,0Ah	
LED, 230V AC, 8h	KWW 018SC	KWD 018SC	8h	LED 3W	2x 4,8V/2,0Ah	
Einzelbatterieleuchten mit Wireless Professional-Modul Self-contained luminaires with Wireless Professional-module						
LED, 230V AC, 3h	KWW 003WL	KWD 003WL	3h	LED 2W	4,8V/2,0Ah	
LED, 230V AC, 3h	KWW 013WL	KWD 013WL	3h	LED 3W	12V/0,8Ah	
LED, 230V AC, 8h	KWW 018WL	KWD 018WL	8h	LED 3W	12V/0,8Ah	
Ausführung Version						
Bestellnummern nach Montageart Order numbers acc. to mounting				Leuchtmittel Illuminant		
Wand wall		Decke ceiling				
Leuchten für Zentralanlagen AC/DC Luminaires for central power systems AC/DC						
LED, 230V AC/DC	KWW 019	KWD 019		LED 3W		
Leuchten für Zentralanlagen AC/DC inkl. Überwachungsbaustein Luminaires for central power systems AC/DC incl. monitoring module						
LED, 230V AC/DC	KWW 019ML	KWD 019ML		LED 3W		

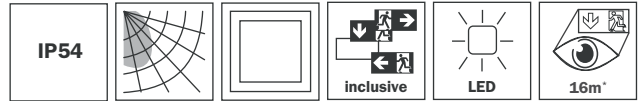

Maße KW Decke
Dimensions KW ceiling

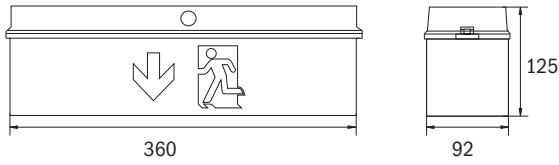

Maße KW Wand
Dimensions KW wall

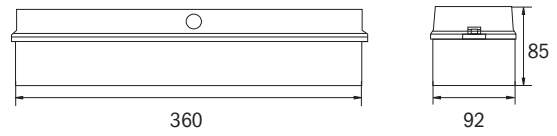

Maße KW Einbaurahmen
Dimensions KW recessed frame

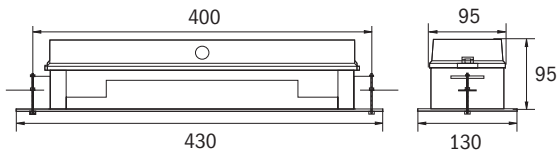

Bohrabstände KW Decke / Wand
Drilling distances KW ceiling / wall

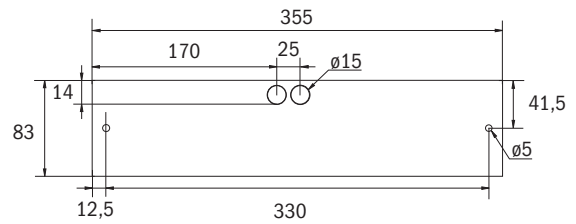

Zubehör / Accessories

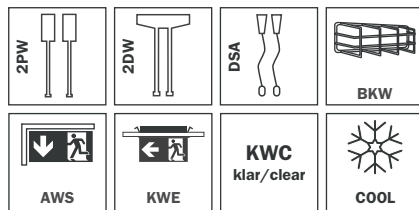

*) Rettungszeichenleuchten sollten für eine eindeutige Erkennbarkeit nicht höher als 20° über der horizontalen Blickrichtung montiert sein.
For a clear identification exit signs should be mounted not higher than 20° above the horizontal line of sight.

U6

Fluchtwegbeleuchtung Emergency route lighting

Die in die Wand integrierte Rettungszeichenleuchte passt sich der Raumgestaltung an. Planungssicherheit erhalten Sie durch werkzeuglosen, variablen Einsatz der Piktogramme vor Ort. LED-Rettungszeichenleuchte zum Wandeinbau nach DIN EN 60598-1, DIN EN 60598-2-22, DIN EN 7010 und DIN EN 1838.

Integrated into the wall escape route indication luminaire adapts to the interior design. You get planning security through toolless, variable use of pictograms on site. LED escape route luminaire for recessed wall mounting to DIN EN 60598-1, EN 60598-2-22, EN 7010 and DIN EN 1838th.



Zinkor, weiß

Blende pulverbeschichtet

Komplettes Piktogrammset (ISO 7010)

IP40

Wandeinbau

-5° bis +40°C

22m Erkennungsweite

Zinc steel, white

cover powder coated

complete set of pictographs (ISO 7010)

IP40

recessed wall mounting

-5° up to +40°C

22m viewing distance

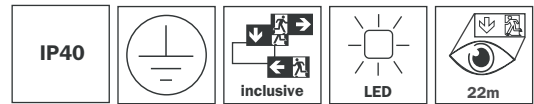

Ausführung Version	Bestellnummern nach Montageart Order numbers acc. to mounting Einbau recessed	Überbrückungszeit Operating Time	Leuchtmittel Illuminant	Batterie Battery
Einzelbatterieleuchten Self-contained luminaires				
LED, 230V AC, 3h	U6E 013	3h	LED 3W	4,8V/2,0Ah
LED, 230V AC, 3h	U6E 018	8h	LED 3W	2x 4,8V/2,0Ah
Einzelbatterieleuchten mit Selbsttestfunktion Self-contained luminaires with SelfControl module				
LED, 230V AC, 3h	U6E 013SC	3h	LED 3W	4,8V/2,0Ah
LED, 230V AC, 3h	U6E 018SC	8h	LED 3W	2x 4,8V/2,0Ah
Einzelbatterieleuchten mit Wireless Professional-Modul Self-contained luminaires with Wireless Professional module				
LED, 230V AC, 3h	U6E 013WL	3h	LED	12V/0,8Ah
Ausführung Version	Bestellnummern nach Montageart Order numbers acc. to mounting Einbau recessed		Leuchtmittel Illuminant	
Leuchten für Zentralanlagen AC/DC Luminaires for central power systems AC/DC				
LED, 230V AC/DC	U6E 019		LED 3W	
Leuchten für Zentralanlagen AC/DC inkl. Überwachungsbaustein Luminaires for central power systems AC/DC incl. monitoring module				
LED, 230V AC/DC	U6E 019ML		LED 3W	

Maße U6
Dimensions U6

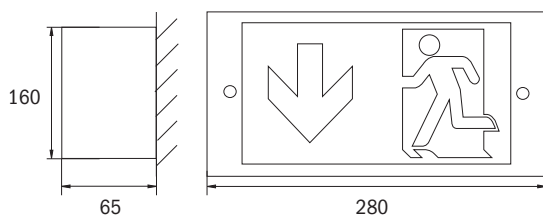

Lochausschnitt U6
Hole cutout U6

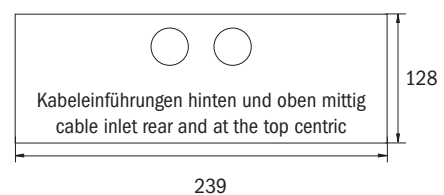

V2W

Edelstahlleuchte High-grade steel luminaire

Hochwertige **vandalensichere** Edelstahlleuchte zur Wandmontage gem. DIN EN 60598-1, DIN EN 60598-2-22 und DIN EN 1838 zur Kennzeichnung und Ausleuchtung der Flucht- und Rettungswege. Erhältlich als EVG- oder Einzelbatterie-Leuchte.

High quality **vandal proof** high-grade steel luminaire for wall mounting according to DIN EN 60598-1, DIN EN 60598-2-22 and EN 1838 for the marking and lighting of escape and rescue routes. Suitable for maintained or non-maintained mode.



Edelstahl V2A (optional V4A)

Kompletter Satz Piktogramme im Lieferumfang enthalten

IP65

Wandmontage (W)

-5° bis +40°C

High-grade steel V2A (V4A optional)

complete set of pictographs included

IP65

wall (W)

-5° up to +40°C